

## TECHINICAL BULLETIN

Rivet Type vs. New NVR Technology

AISIN is converting the older Rivet Type Clutch Cover into the newest Noise Vibration Reduction Type (NVR) Technology. Since the Original Equipment Clutch Systems that AISIN supplies for the Automotive Manufacturers are being converted to the new technology, AISIN Aftermarket is following their lead. Although they may look physically different, it is just an illusion. The NVR Cover fitment is identical to the older Rivet Type, except with technological improvements in function, durability and driveability.

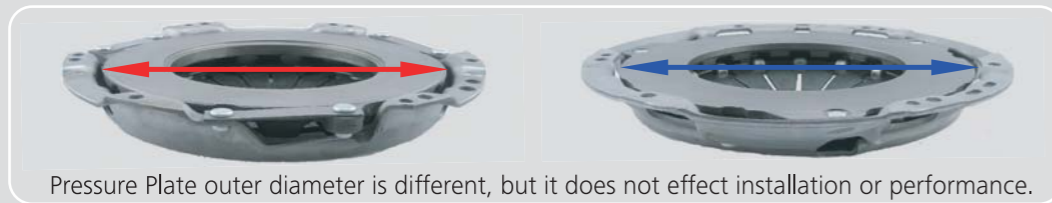
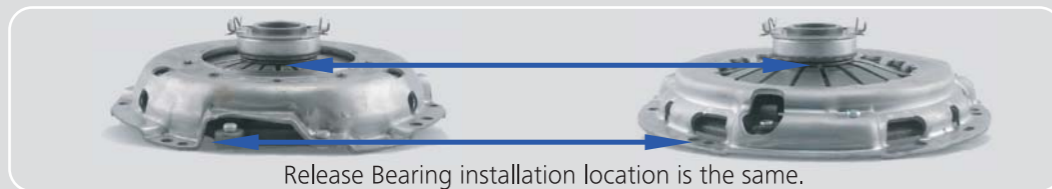
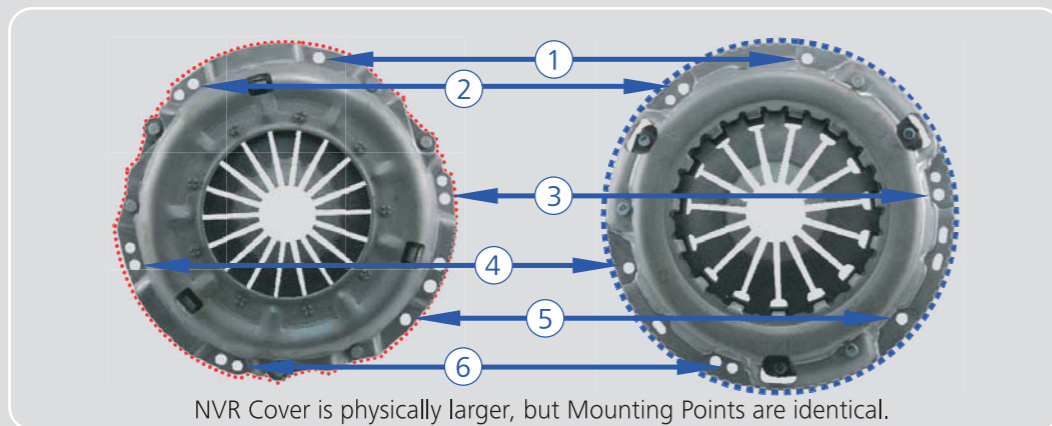
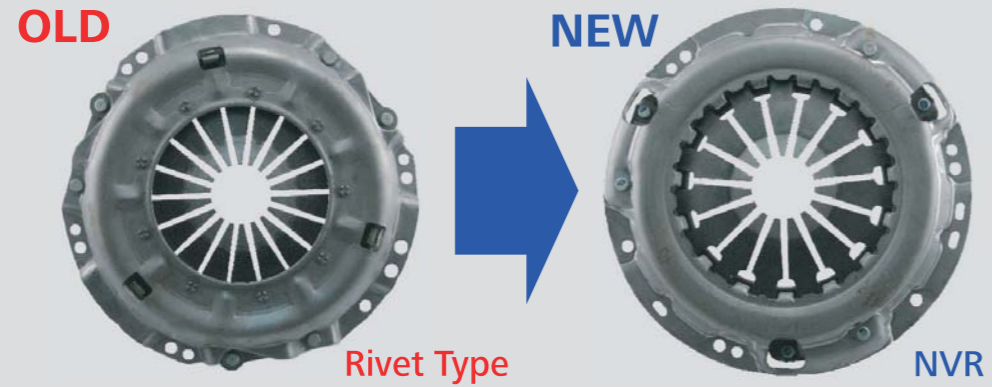

## TECHINICAL BULLETIN

Rivet Type vs. New NVR Technology

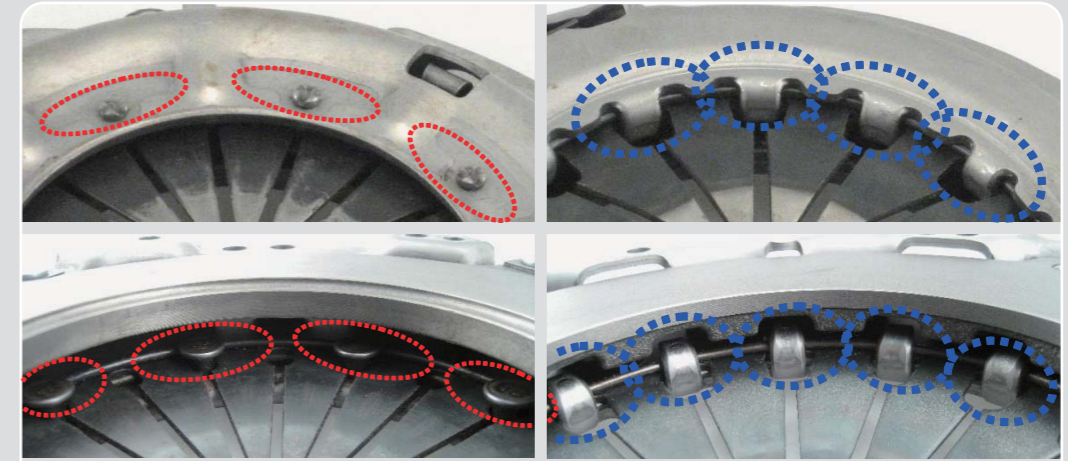

NVR Technology enables stronger spring support, resulting in better clutch control.

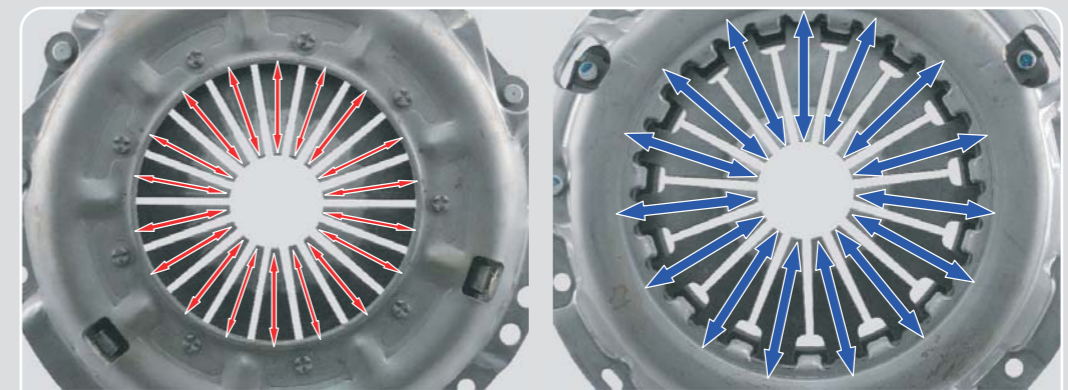

NVR Covers have fewer Fingers, but the Diaphragm Spring Fingers are thicker and stronger .



Straps and Levers are enclosed, increasing the cover rigidity.

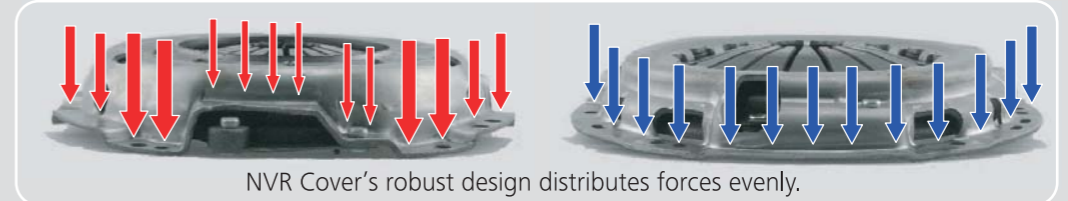

NVR Cover's robust design distributes forces evenly.